

REV.	DESCRIPTION	DATE	DWG.	CHKD
0	RELEASED	'07.06.12	B.K	T.H
A	REVISED	'09.06.25	B.K	T.H
B	REVISED	'10.02.16	B.K	T.H
C	REVISED	'10.10.08	B.K	T.H
D	REVISED	'11.12.01	B.K	T.H
E	REVISED	'12.10.09	B.K	T.H

NOTES.

- 1. 材質：ハウジング：LCP樹脂、UL94V-0、色：黒色
 コントクト：銅合金
 メタルラッチ：ステンレス
 MATERIAL: HOUSING: LCP, UL94V-0, COLOR: BLACK
 CONTACT: COPPER ALLOY
 METAL LATCH: SUS
- 2. メッキ：コンタクト（接点部、半田付け部）：金メッキ0.0075μmMIN, ニッケル下地1.5μmMIN.
 PLATING: CONTACT (CONTACT POINT, SOLDER AREA):
 Au PLATE 0.0075μm MIN, Ni UNDER PLATE 1.5μm MIN.
- 3. コネクタを平坦面に置き、端子半田付け部の浮きは、0.1mm以下
 MUST BE MEASURED FLOATING AMOUNT OF CONTACT TAILS
 FROM DATAM SURFACE IS 0.1mm MAX.

- 4. 倍率適用外寸法
 NOT TO SCALE.
- 5. 公差非累積
 TOLERANCES NON-CUMULATIVE
- 6. 他社のソケット用
 FOR SOCKET OF THE OTHER COMPANIES

1.5V	CA0459-204B01	CA0459-204B31	CA0459-204B21
POWER SUPPLY	PART NO. OF CONNECTOR	PART NO. OF PACKAGED PRODUCT (WITH HARD TRAY)	PART NO. OF PACKAGED PRODUCT (WITH EMBOSS)

QTY PER ASSY					NOTE	FINISH	PART NO.	NAME		NO.
※	※	※	※	※	MATERIAL	NET WEIGHT	COLOR	GENERAL TOLERANCE		UNIT:mm
※	※	※	※	※	*****	***g	*****	±0.2 ±3°		
※	※	※	※	※	FIN.&TREAT	GROSS WEIGHT	SCALE	SIZE		
※	※	※	※	※	*****	***g	2:1	A3		
※	※	※	※	※	CUSTOMER	PART NO.		CA0459-204B**		REV.
※	※	※	※	※	*****	PROPOSAL NO.		****-***-**-**		REV.
※	※	※	※	※	CUSTOMER PART NO.	NAME		MSH TECHNOLOGY INC.		NO.
※	※	※	※	※	*****	NAME		DDR S.O DIMM SOCKET H=9.2 TYPE A SMALL LATCH		(SHEET 1 OF 6)
※	※	※	※	※	APP. '07.06.12	CHKD '07.06.12	DWG. '07.06.12	FOR 204PIN DDR S.O DIMM(DDR3)		
※	※	※	※	※	T.HASHIMOTO	T.HASHIMOTO	B.KA			

REV.	DESCRIPTION	DATE	DWG.	CHKD
	SEE SHEET 1 OF 6			

△ ラッチ可動範囲
部品実装禁止範囲
LATCH MOVING AREA
NO COMPONENT AREA

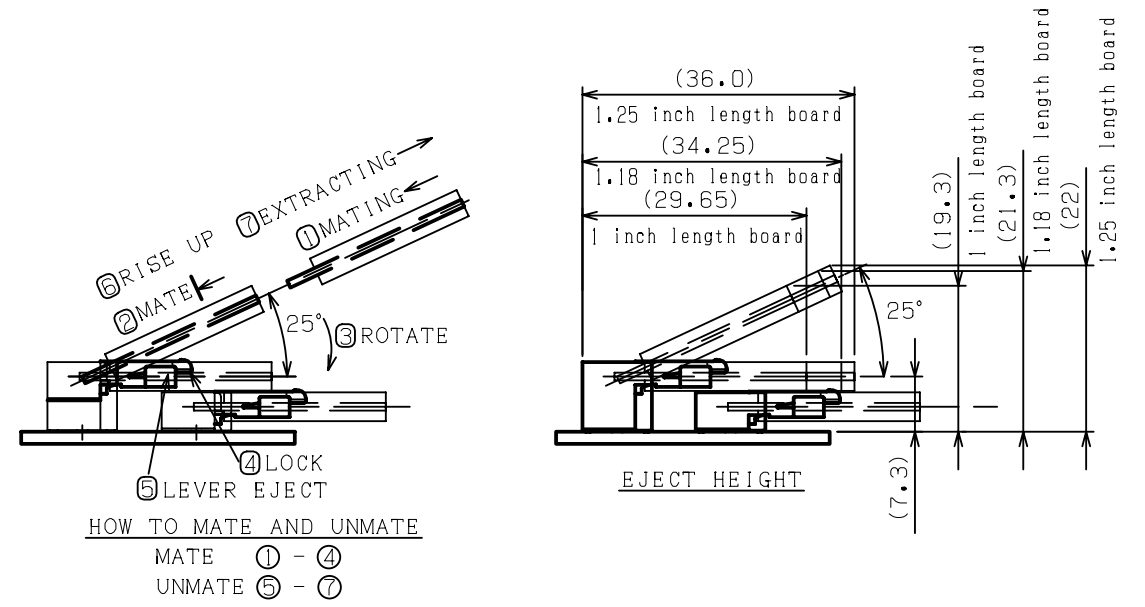
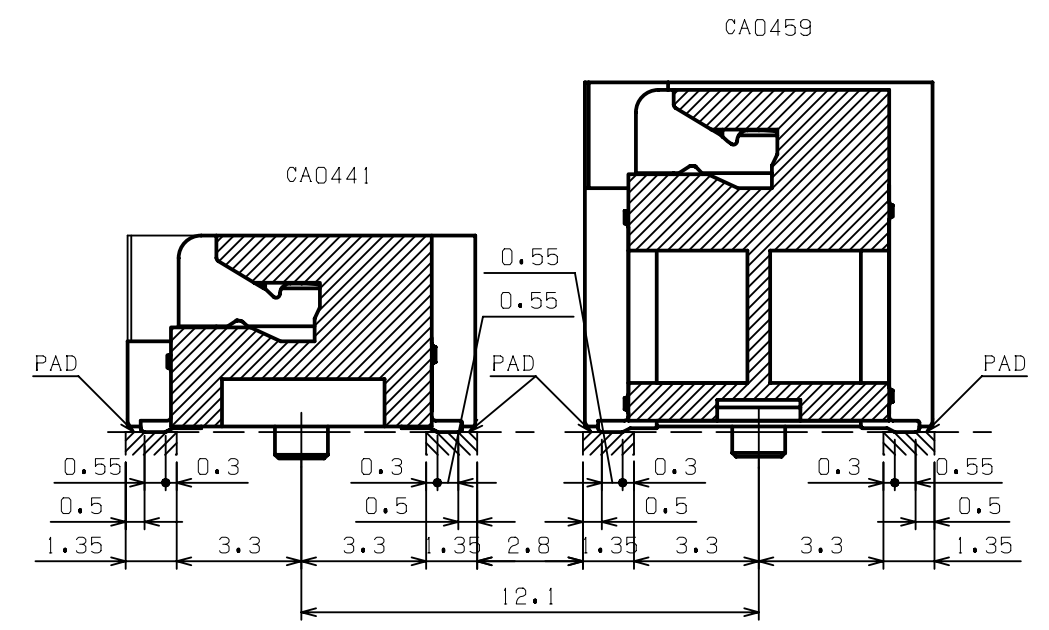
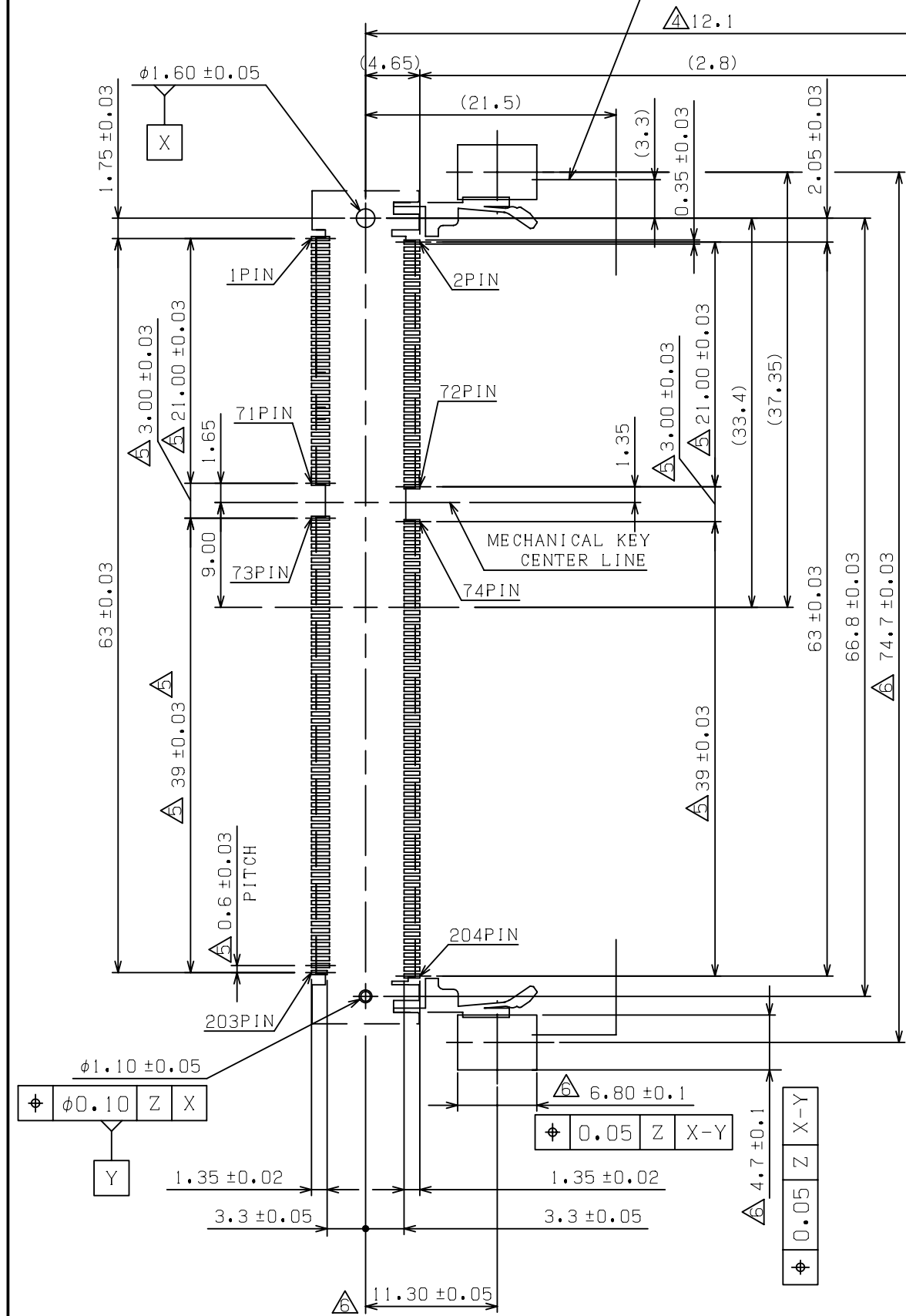

QTY PER ASSY	NOTE	FINISH	PART NO.	N A M E	NO.
*****	MATERIAL *****	NET WEIGHT *****g	COLOR *****	GENERAL TOLERANCE ±0.2 ±3°	UNIT:mm
*****	FIN.&TREAT *****	GROSS WEIGHT *****g	SCALE 2:1	SIZE A3	
*****	CUSTOMER *****	PART NO. CA0459-204B**		REV. E	
*****	CUSTOMER PART NO. *****	PROPOSAL NO. *****-****-**-**		REV. *	
*****	美星鴻科技股份有限公司 MSH TECHNOLOGY INC.		NAME (SHEET 2 OF 6) DDR S.O DIMM SOCKET H=9.2 TYPE A SMALL LATCH		
*****	APP. 07.06.12	CHKD 07.06.12	DWG. 07.06.12	FOR 204PIN DDR S.O DIMM(DDR3)	
*****	T.HASHIMOTO	T.HASHIMOTO	B.KA		

(CUSTOMER DRAWING)

REV.	DESCRIPTION	DATE	DWG.	CHKD
	SEE SHEET 1 OF 6			

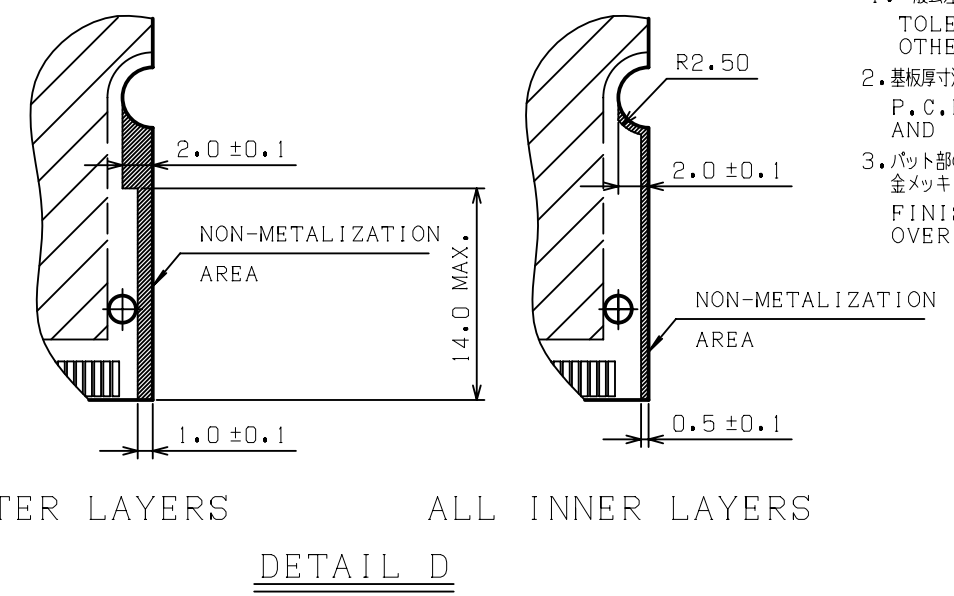
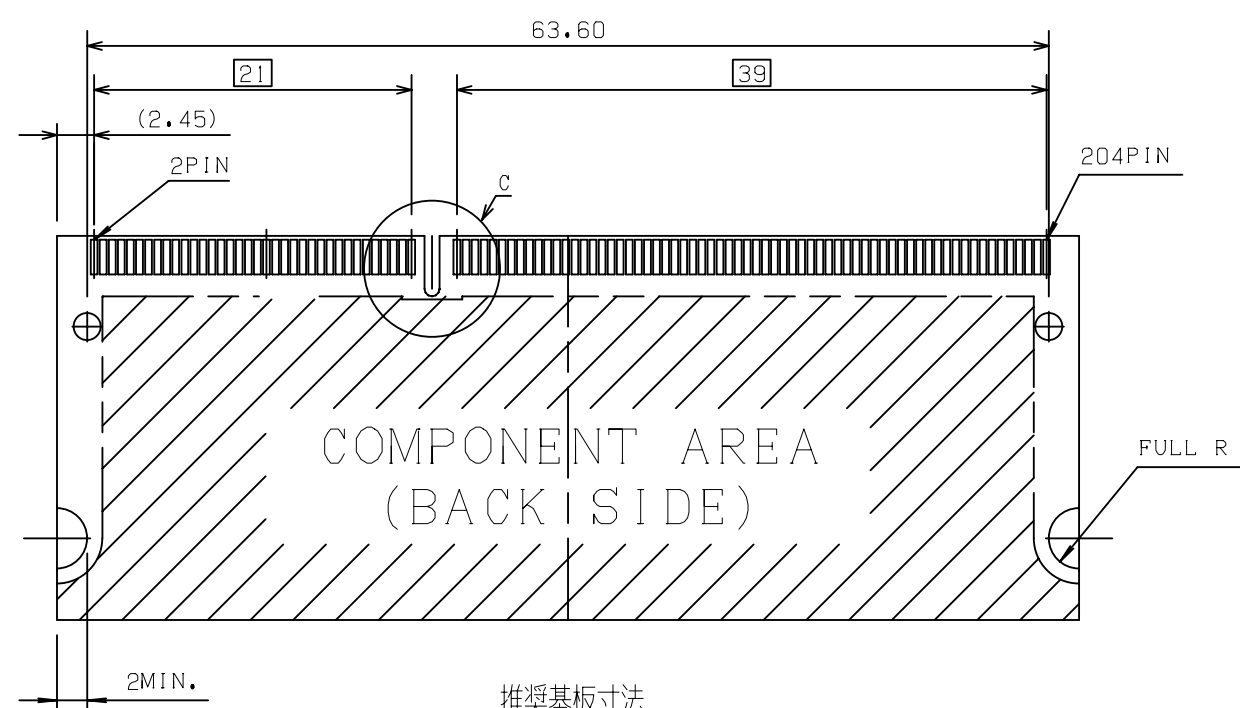
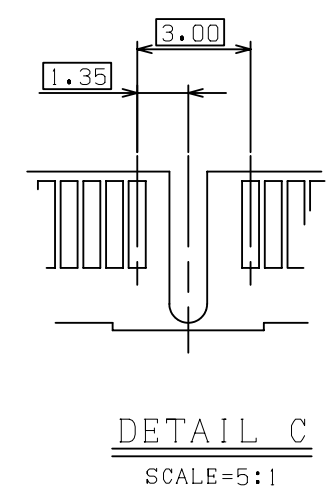
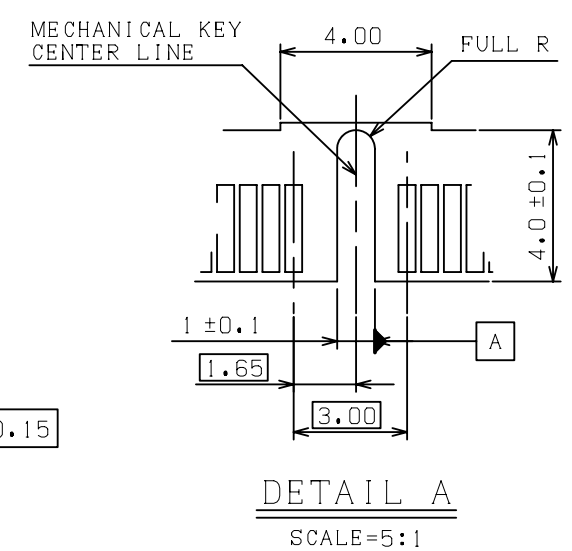
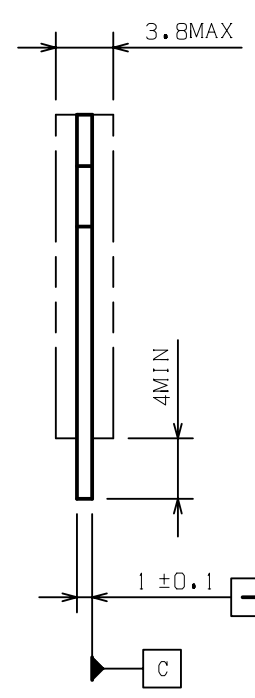
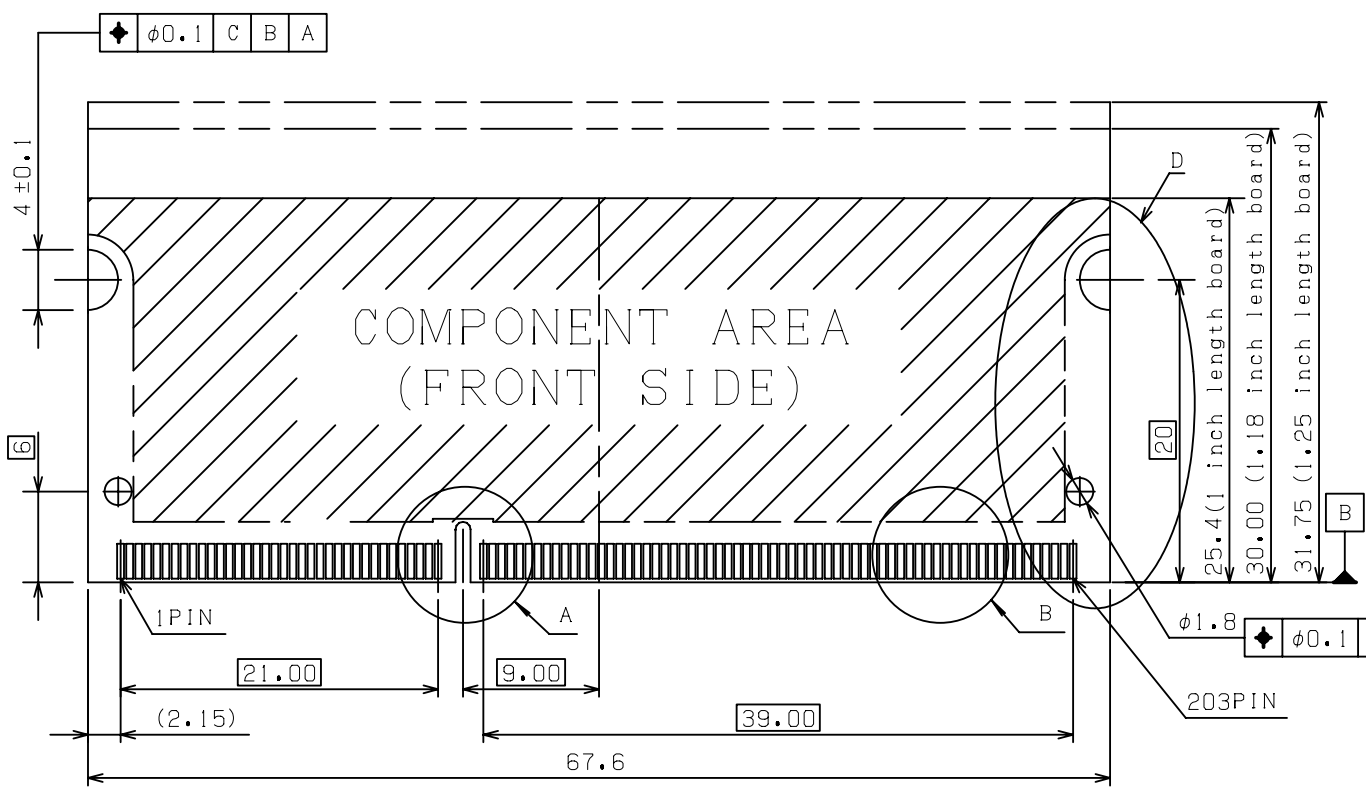

注記: (SHEET 3 に適用)
 NOTES: (APPLIED TO SHEET 3)

- 一般公差±0.15
 TOLERANCES ON ALL DIMENSION ±0.15 UNLESS OTHERWISE SPECIFIED.
- 基板厚寸法は、メッキ厚を含む。
 P.C. BOARD THICKNESS APPLIES ACROSS TABS AND INCLUDES PLATING AND/OR METALIZATION.
- パット部の仕上げ: ニッケル下地メッキ 0.002MIN. 厚の上に、金メッキ 0.000756MIN. 厚を施す。
 FINISH OF PAD: GOLD PLATING 0.00076MIN. OVER Ni PLATING 0.002MIN.

推奨基板寸法
 RECOMMENDED MATING
 P.C. BOARD DIM.

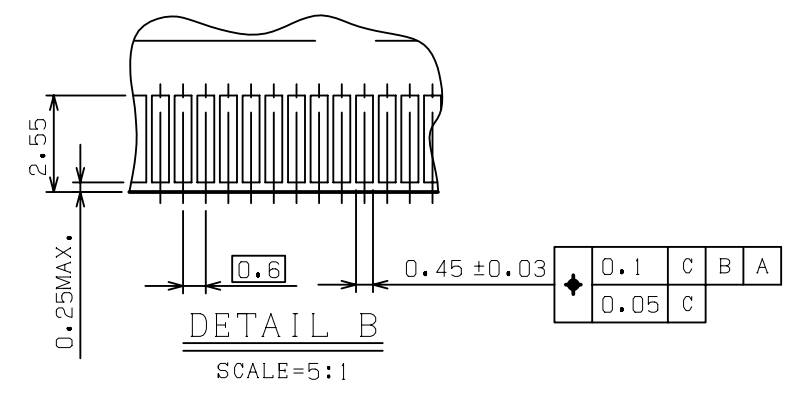

QTY PER ASSY					NOTE	FINISH	PART NO.	NAME		NO.
**	**	**	**	**	MATERIAL		NET WEIGHT	COLOR	GENERAL TOLERANCE	UNIT:mm
**	**	**	**	**	*****	***g	*****	±0.2 ±3°		
**	**	**	**	**	FIN.&TREAT		GROSS WEIGHT	SCALE	SIZE	
**	**	**	**	**	*****	***g	2:1	A3		
**	**	**	**	**	CUSTOMER	*****	PART NO.	CA0459-204B**		REV. E
**	**	**	**	**	CUSTOMER PART NO.	*****	PROPOSAL NO.	****-***-**-**		REV. *
**	**	**	**	**	美星鴻科技股份有限公司 MSH TECHNOLOGY, INC.		NAME		(SHEET 3 OF 6)	
**	**	**	**	**	APP. 07.06.12	CHKD 07.06.12	DWG. 07.06.12	DDR S.O DIMM SOCKET H=9.2 TYPE A SMALL LATCH		
**	**	**	**	**	T.HASHIMOTO	T.HASHIMOTO	B.KA	FOR 204PIN DDR S.O DIMM(DDR3)		

REV.	DESCRIPTION	DATE	DWG.	CHKD
	SEE SHEET 1 OF 6			

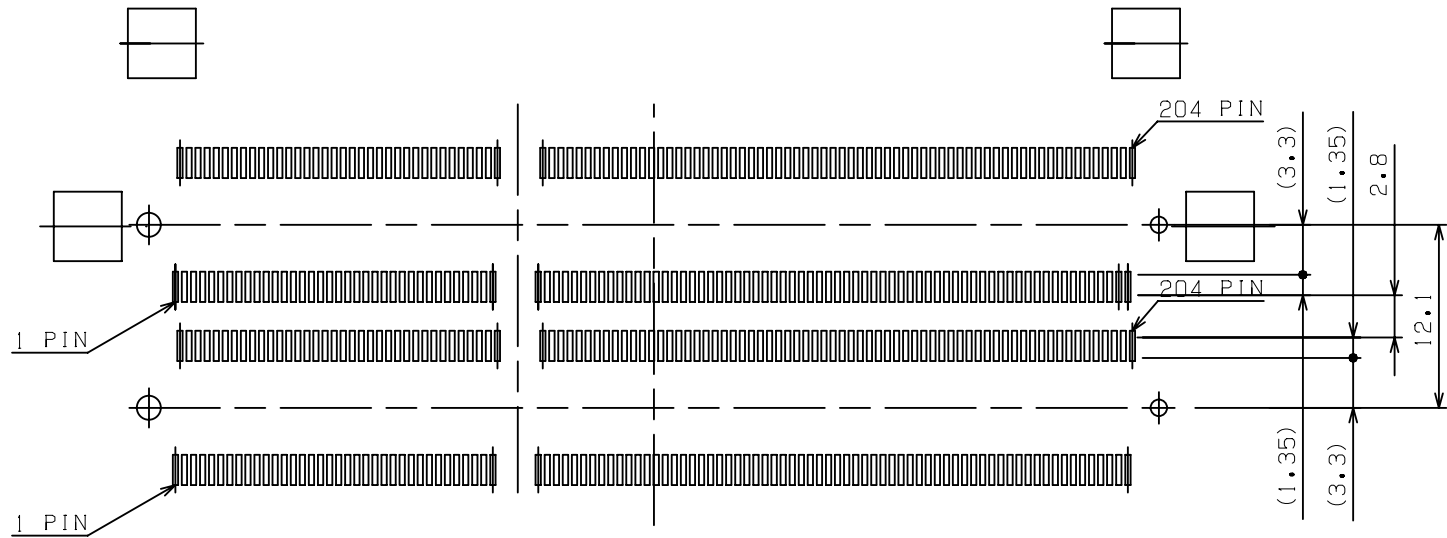

推奨基板レイアウト寸法
RECOMMENDED MOUNTAINING
P.C. BOARD PATTERN LAYOUT DIM.

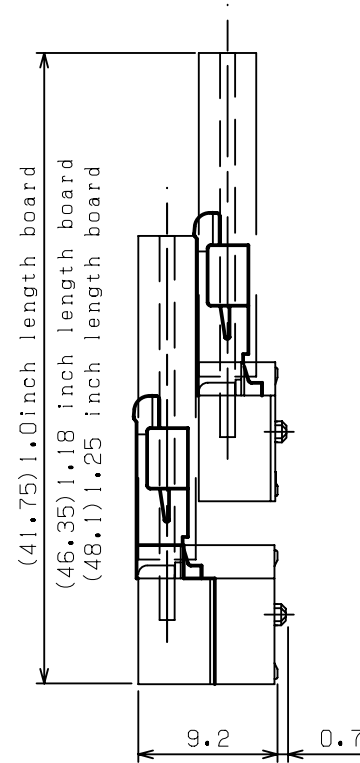
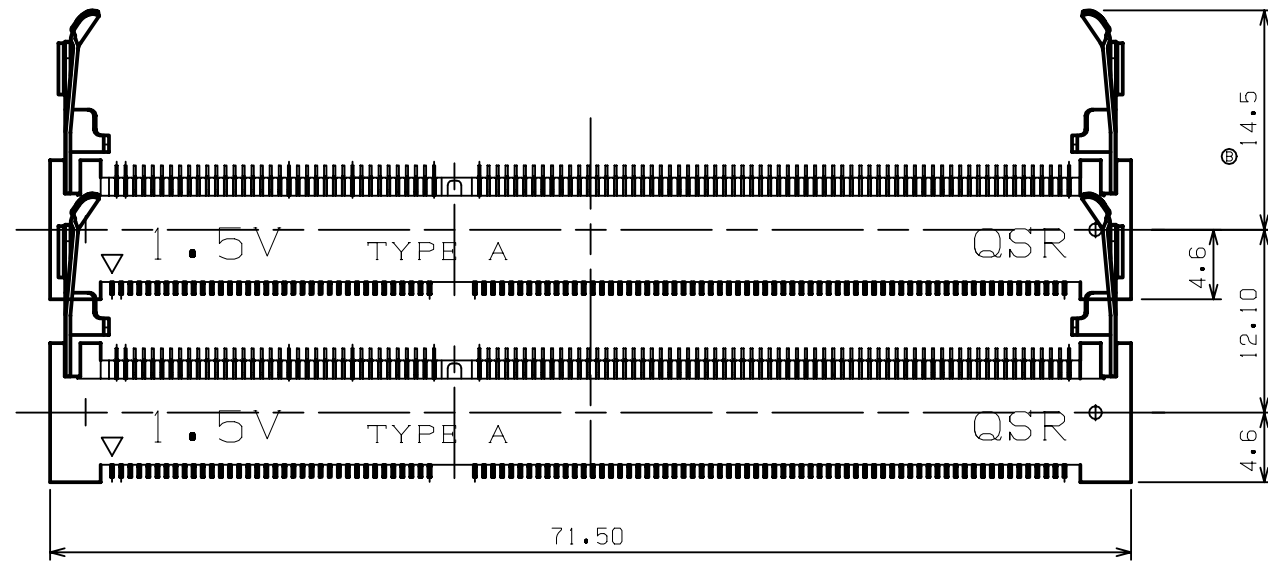

Combination Dimension for H=5.2 connector
(Only the combination of the P/N CA0441 (H=5.2) and CA0459 (H=9.2) is possible.)

QTY PER ASSY					NOTE	FINISH	PART NO.	NAME		NO.	
*	*	*	*	*	MATERIAL		NET WEIGHT	COLOR	GENERAL TOLERANCE	UNIT:mm	
*	*	*	*	*		*****	***g	*****	±0.2 ±3°		
-	-	-	-	-	FIN.&TREAT		GROSS WEIGHT	SCALE	SIZE		
*	*	*	*	*		*****	***g	2:1	A3		
-	-	-	-	-	CUSTOMER		PART NO.	CA0459-204B**		REV. E	
*	*	*	*	*		*****				REV. *	
*	*	*	*	*	CUSTOMER PART NO.		PROPOSAL NO.	****-***-**-**			
*	*	*	*	*		*****					
*	*	*	*	*	美星鴻科技股份有限公司 MSH TECHNOLOGY INC.			NAME	DDR S.O DIMM SOCKET H=9.2 TYPE A SMALL LATCH		(SHEET 5 OF 6)
*	*	*	*	*	APP. 07.06.12	CHKD 07.06.12	DWG. 07.06.12	FOR 204PIN DDR S.O DIMM(DDR3)			
*	*	*	*	*	T.HASHIMOTO	T.HASHIMOTO	B.KA				

6

5

4

3

2

1

REV.	DESCRIPTION	DATE	DWG.	CHKD
	SEE SEE1 1 OF 6			

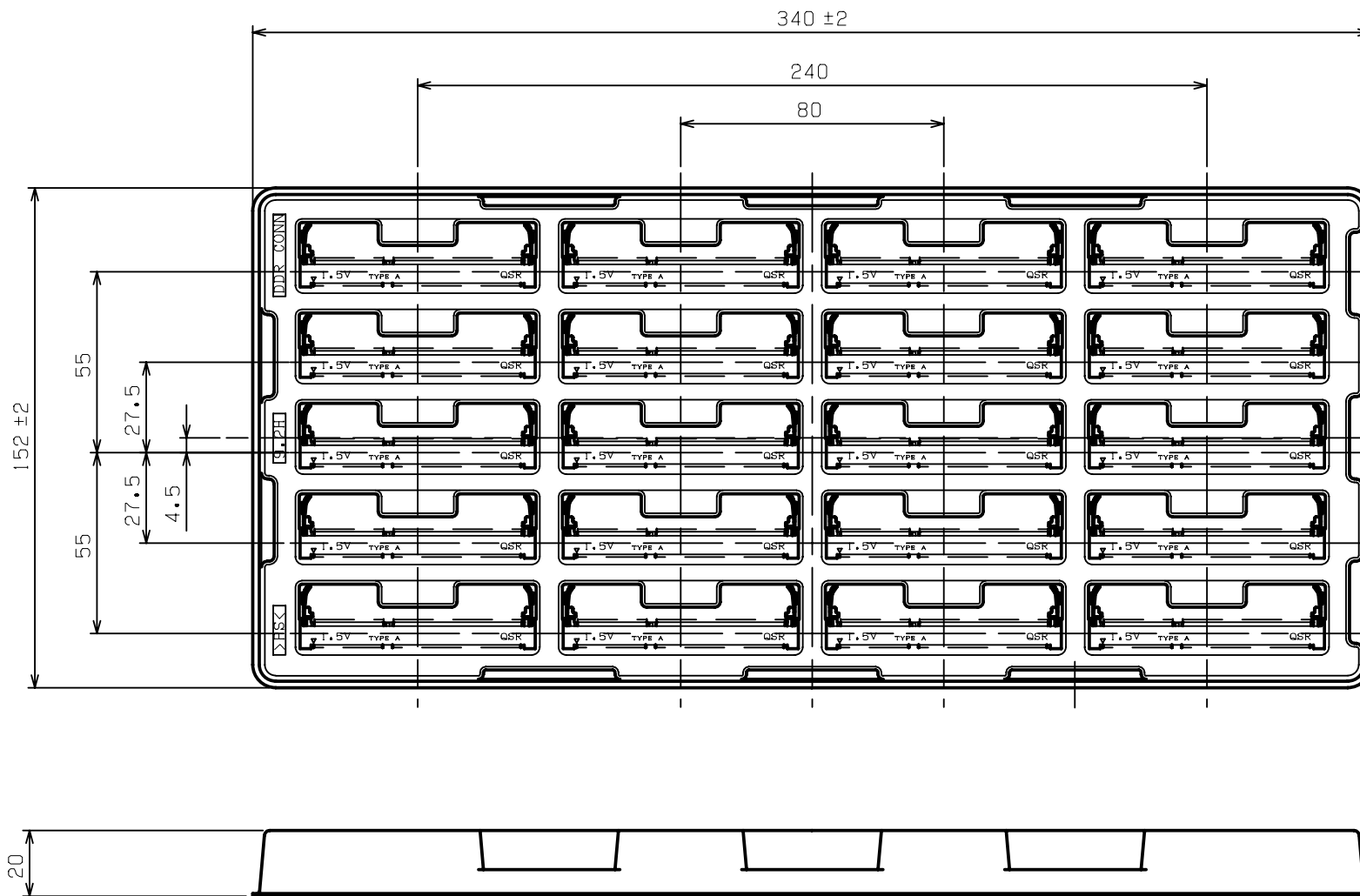

SOFT TRAY PACKAGING

20	CA0459-204B01	CA0459-204B31
QTY.	PART NO. OF CONNECTOR	PART NO. OF PACKAGED PRODUCT (WITH SOFT TARY)

QTY PER ASSY					NOTE	FINISH	PART NO.	NAME		NO.
※	※	※	※	※	MATERIAL	*****	NET WEIGHT	COLOR	GENERAL TOLERANCE	UNIT:mm
※	※	※	※	※	FIN.&TREAT	*****	GROSS WEIGHT	SCALE	SIZE	☐ ⊙
※	※	※	※	※	CUSTOMER	*****	PART NO.	CA0459-204B**		REV. E
※	※	※	※	※	CUSTOMER PART NO.	*****	PROPOSAL NO.	***-**-**-**		REV. *
※	※	※	※	※	美星鴻科技股份有限公司 MSH TECHNOLOGY, INC.			NAME (SHEET 4 OF 6)		
※	※	※	※	※	APP. '07.06.12	CHKD '07.06.12	DWG. '07.06.12	DDR S.O DIMM SOCKET H=9.2 TYPE A SMALL LATCH		
※	※	※	※	※	T.HASHIMOTO	T.HASHIMOTO	B.KA	FOR 204PIN DDR S.O DIMM(DDR3)		

6

5

4

3

2

1

DIRECTION OFF TOP OF REEL

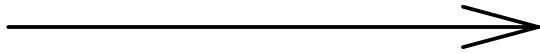

REV.	DESCRIPTION	DATE	DWG.	CHKD
	SEE SHEET 1 OF 5			

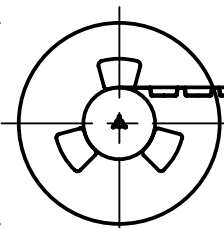
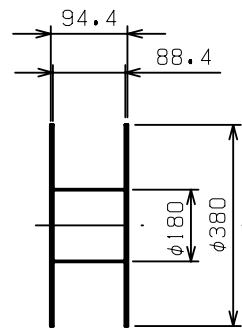
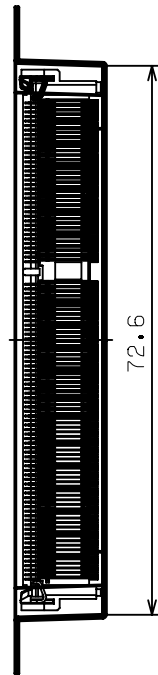
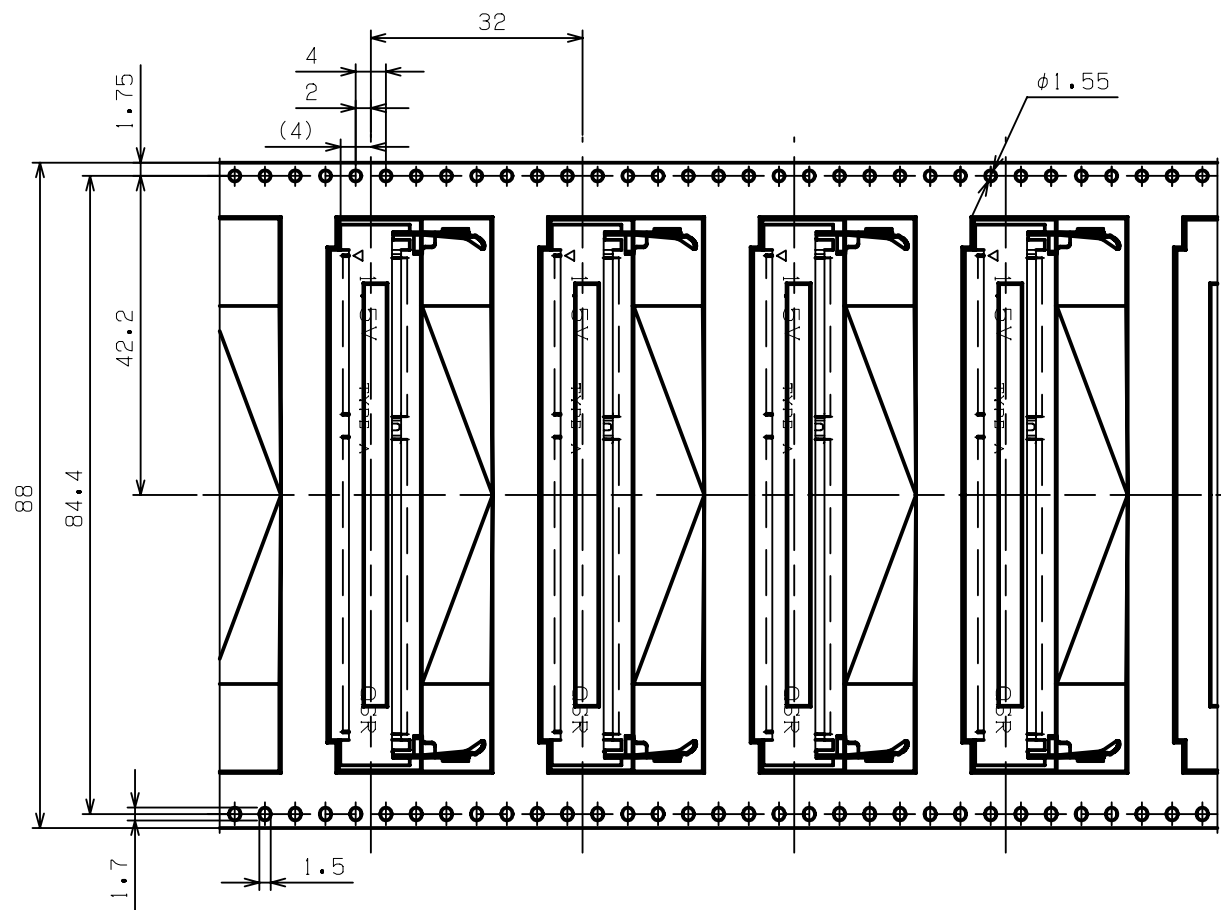

WINDING THE COVER TAPE
AROUND THE OUTER
PERIPHERY IN A TURN.
剥離角度
PEELING ANGLE
165° to 180°

空部300mm程度 200 Pockets 製品充填部 100mm MIN. 空部300mm程度
WITHOUT CHARGE WITH PRODUCT APPROX CHARGE WITHOUT CHARGE APPROX

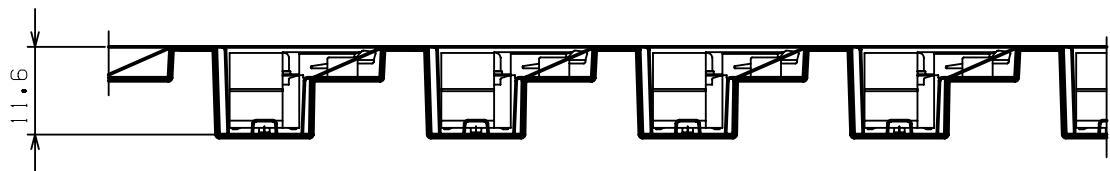

200	CA0459-204B01	CA0459-204B21
QTY.	PART NO. OF CONNECTOR	PART NO. OF PACKAGED PRODUCT (WITH EMBOSS TAPE)

QTY PER ASSY					NOTE	FINISH	PART NO.	NAME		NO.
※	※	※	※	※	MATERIAL	NET WEIGHT	COLOR	GENERAL TOLERANCE	UNIT:mm	
※	※	※	※	※	*****	***g	*****	±0.2 ±3°	A3	
※	※	※	※	※	FIN.&TREAT	GROSS WEIGHT	SCALE	SIZE	A3	
※	※	※	※	※	*****	***g	1:1	A3		UNIT:mm
※	※	※	※	※	CUSTOMER	PART NO.		CA0459-204B**		REV. E
※	※	※	※	※	*****	PROPOSAL NO.		***-**-**-**		REV. *
※	※	※	※	※	CUSTOMER PART NO.	NAME		MSH TECHNOLOGY INC.		(SHEET 6 OF 6)
※	※	※	※	※	*****	NAME		DDR S.O DIMM SOCKET H=9.2 TYPE A SMALL LATCH		
※	※	※	※	※	APP. '07.06.12	CHKD '07.06.12	DWG. '07.06.12	FOR 204PIN DDR S.O DIMM(DDR3)		
※	※	※	※	※	T.HASHIMOTO	T.HASHIMOTO	B.KA			

XXXXX

(CUSTOMER DRAWING)